

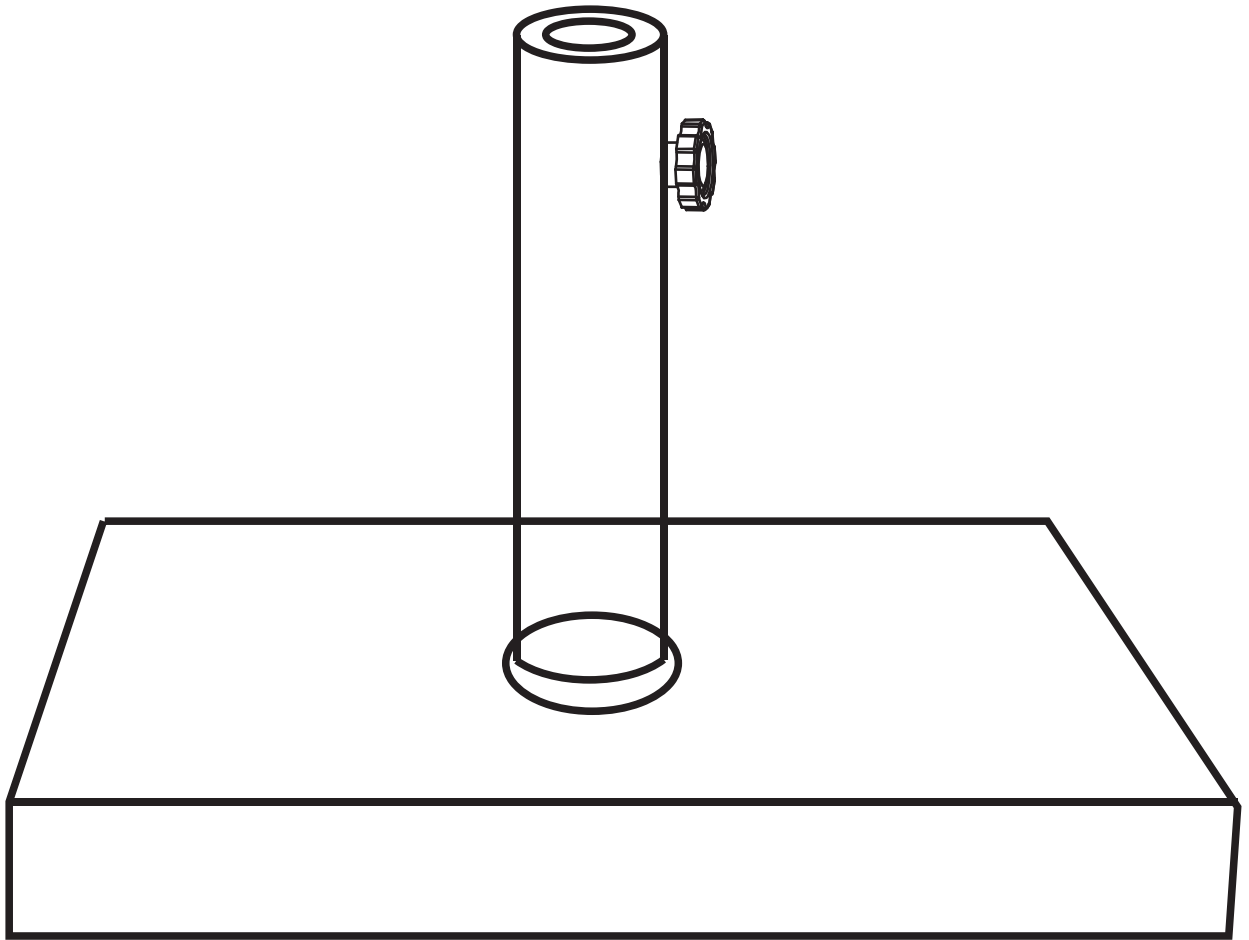

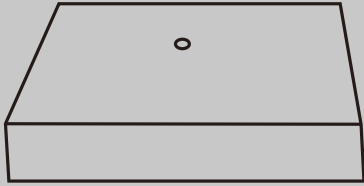

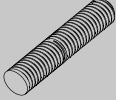



24104

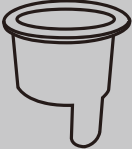
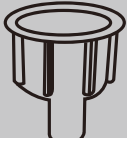

## Teile/Part

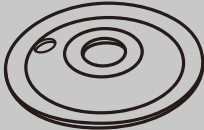
A		Fuß/Base	1
B		Schraube/Screw	1
C		Stahlrohr/Steel tube	1
D		Durchmesser/Diameter 35MM Plastikadapter/Plastic Adapter	1
E		Durchmesser/Diameter 38MM Plastikadapter/Plastic Adapter	1
F		Durchmesser/Diameter 48MM Plastikadapter/Plastic Adapter	1
G		Montagehülse/Location Sleeve	1
H		Feststellknopf/Tightening Knob	1
I		Verbindungskappe/ Dress Collar	1
J		Höhenverstellbarer Fuß/ Adjustable foot	4

# Montage/Assembly

# Benötigte Teile/Parts required

**1**

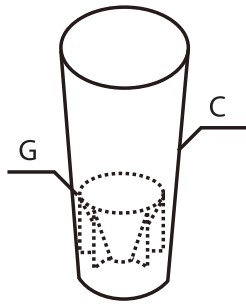

**C**

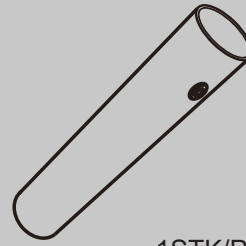

1STK/PC

**G**



1STK/PC

**2**

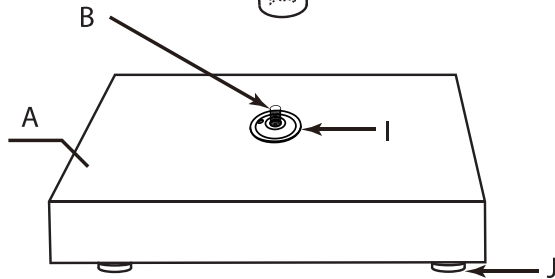

**A**



1STK/PC

**B**

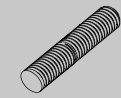

1STK/PC

**D**



1STK/PC

**E**

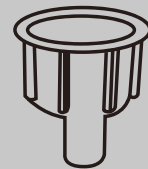

1STK/PC

**F**



1STK/PC

**I**



1STK/PC

**J**



4STK/PCS

**3**

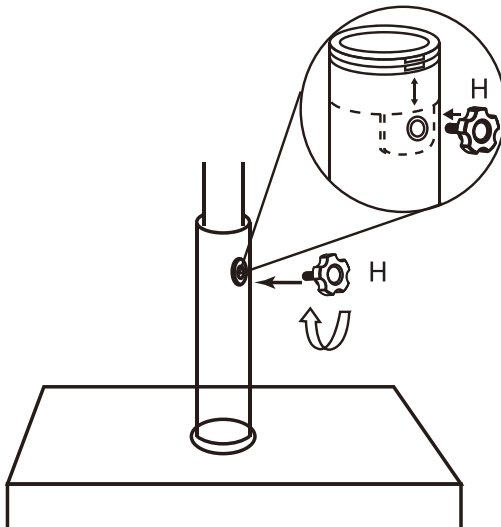

**H**



1STK/PC